

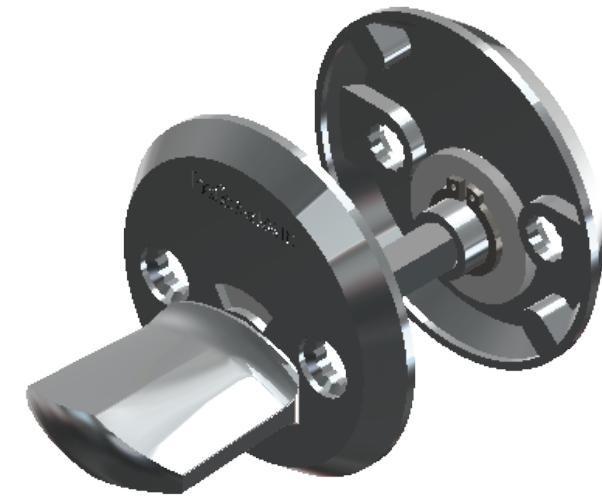

Rev	Note	CreatedBy	Appr.By	Appr.Date

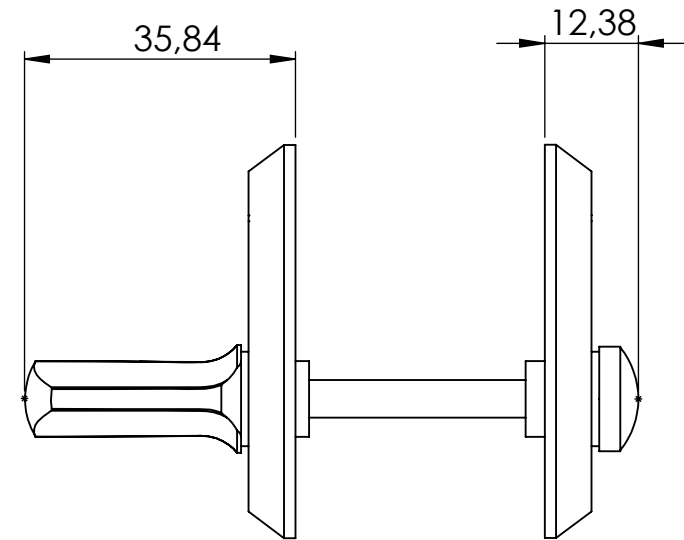
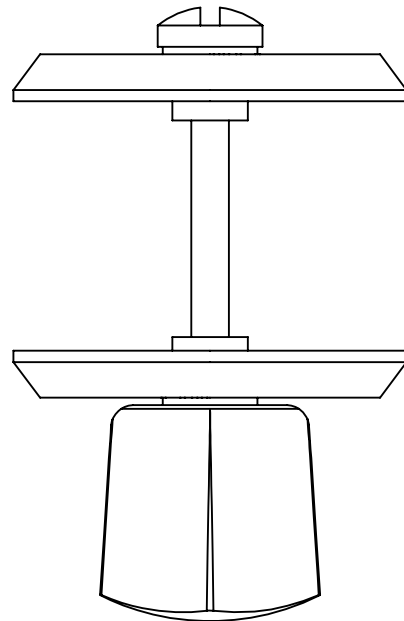
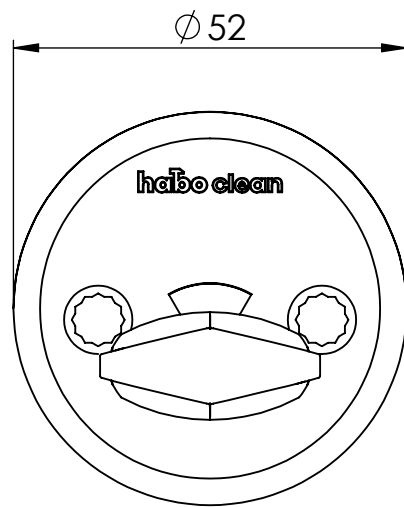
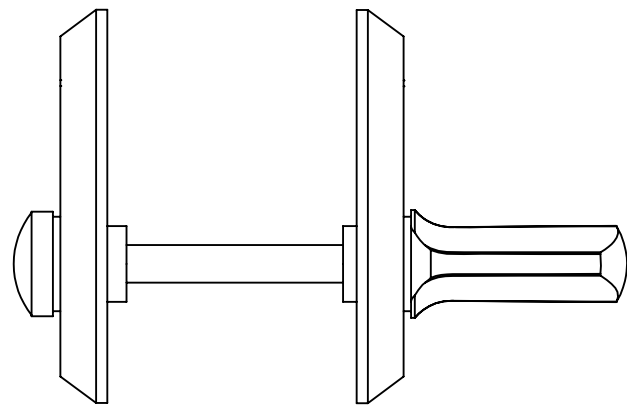
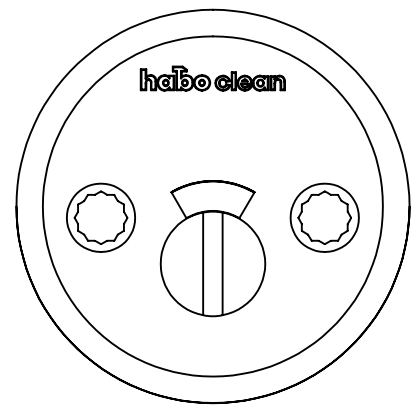

			Tolerance		Project
	Sign.	Date	Surface treatment		Weight
Drawn	CF	2017-09-13	Surface finish		Scale 1:1
Appr.			Heat treatment		Material
			Title/Description		Sheet 1/1
					Rev
				Drawing number	17240